

Istk. som tegnet, Istk. modsat.
Ang. plac. se tegn. 18W-15.210

Betegnelse				bukket plade	
Ant. i alt.	Pos.	Mat.	flussj.		
Ordr.	SML	6898	Tegn. 18W-15.220		

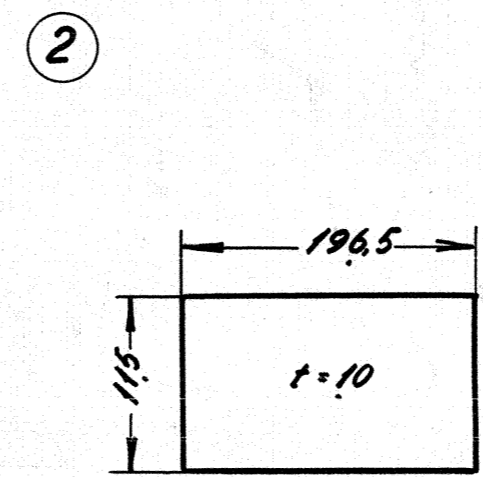

Ang. plac. se tegn. 18W-15.210

Betegnelse				afslivningsplade	
Ant. i alt.	Pos.	Mat.	flussj.		
Ordr.	SML	6898	Tegn. 18W-15.220		

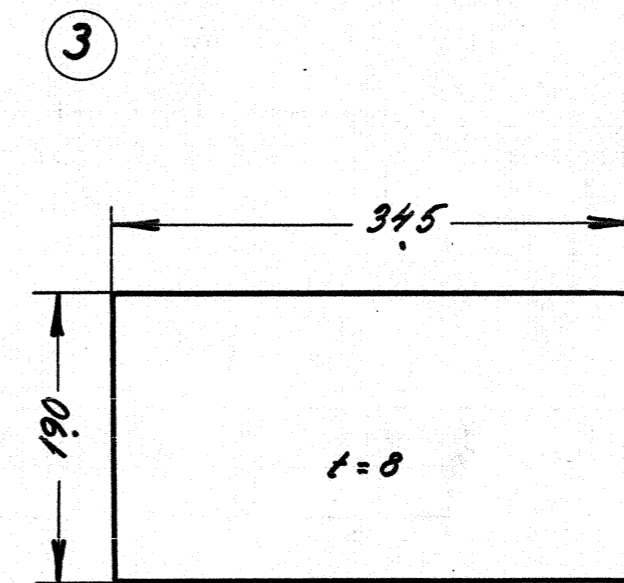

Ang. plac. se tegn. 18W-15.210

Betegnelse				afslivningsplade	
Ant. i alt.	Pos.	Mat.	flussj.		
Ordr.	SML	6898	Tegn. 18W-15.220		

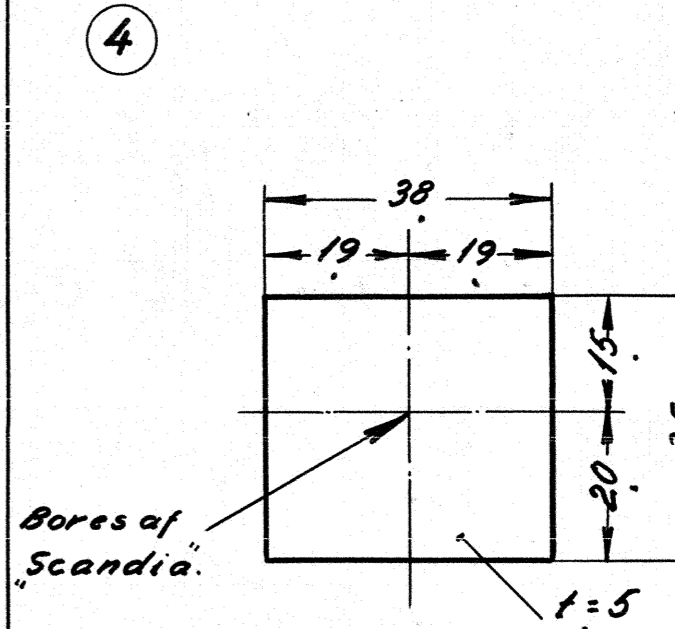

Ang. plac. se tegn. 18W-15.210

Betegnelse				lap	
Ant. i alt.	Pos.	Mat.	flussj.		
Ordr.	SML	6898	Tegn. 18W-15.220		

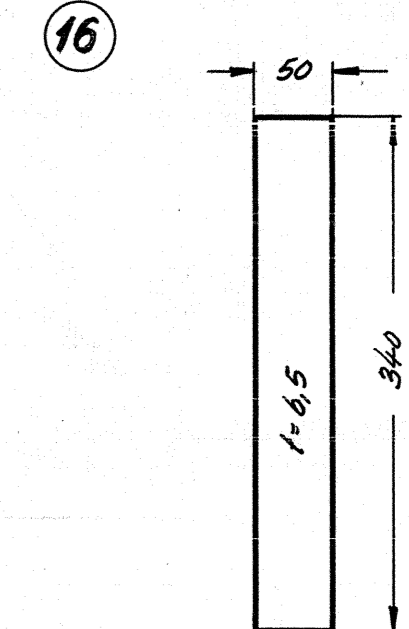

Ang. plac. se pos. 9

betegnelse				mellemlæg	
Ant. i alt.	Pos.	Mat.	flussj.		
Ordr.	SML	6898	Tegn. 18W-15.220		

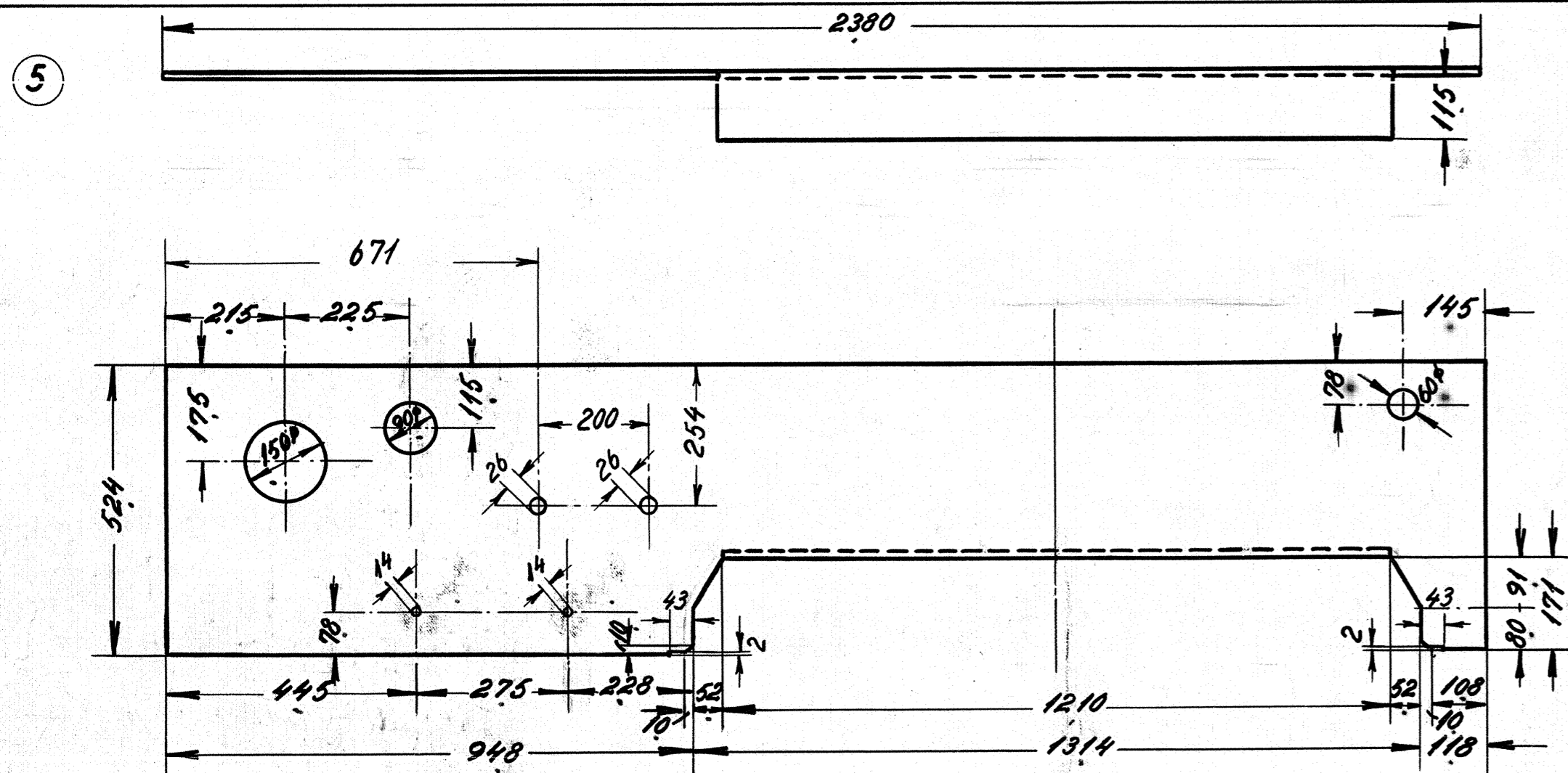

Istk. som tegnet, Istk. modsat.
Ang. plac. se tegn. 18W-15.210

Betegnelse				bukket plade	
Ant. i alt.	Pos.	Mat.	flussj.		
Ordr.	SML	6898	Tegn. 18W-15.220		

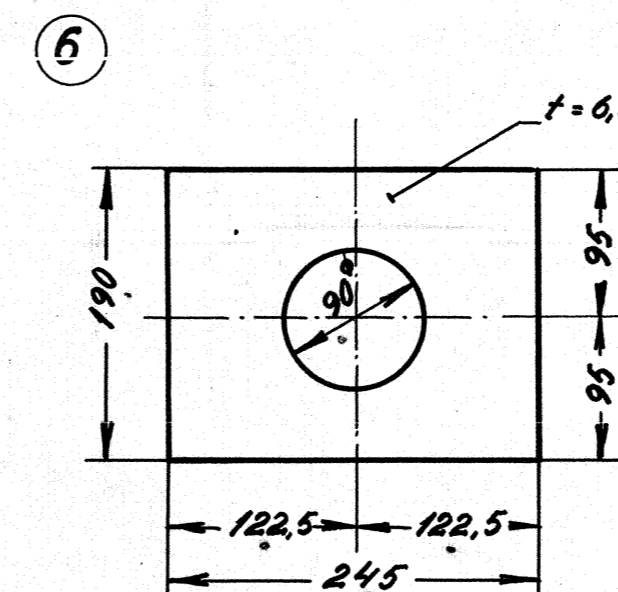
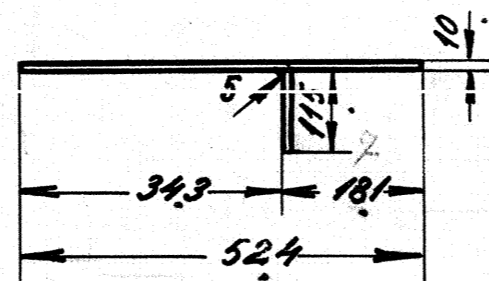

Ang. plac. se tegn. 18W-15.210

Betegnelse				afslivningsplade	
Ant. i alt.	Pos.	Mat.	flussj.		
Ordr.	SML	6898	Tegn. 18W-15.220		

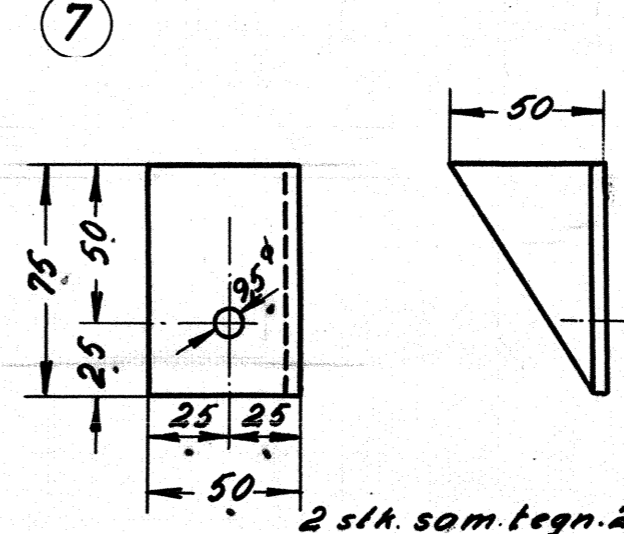

Ang. plac. se tegn. 18W-15.210

Betegnelse				vinkelapp	
Ant. i alt.	Pos.	Mat.	flussj.		
Ordr.	SML	6898	Tegn. 18W-15.220		

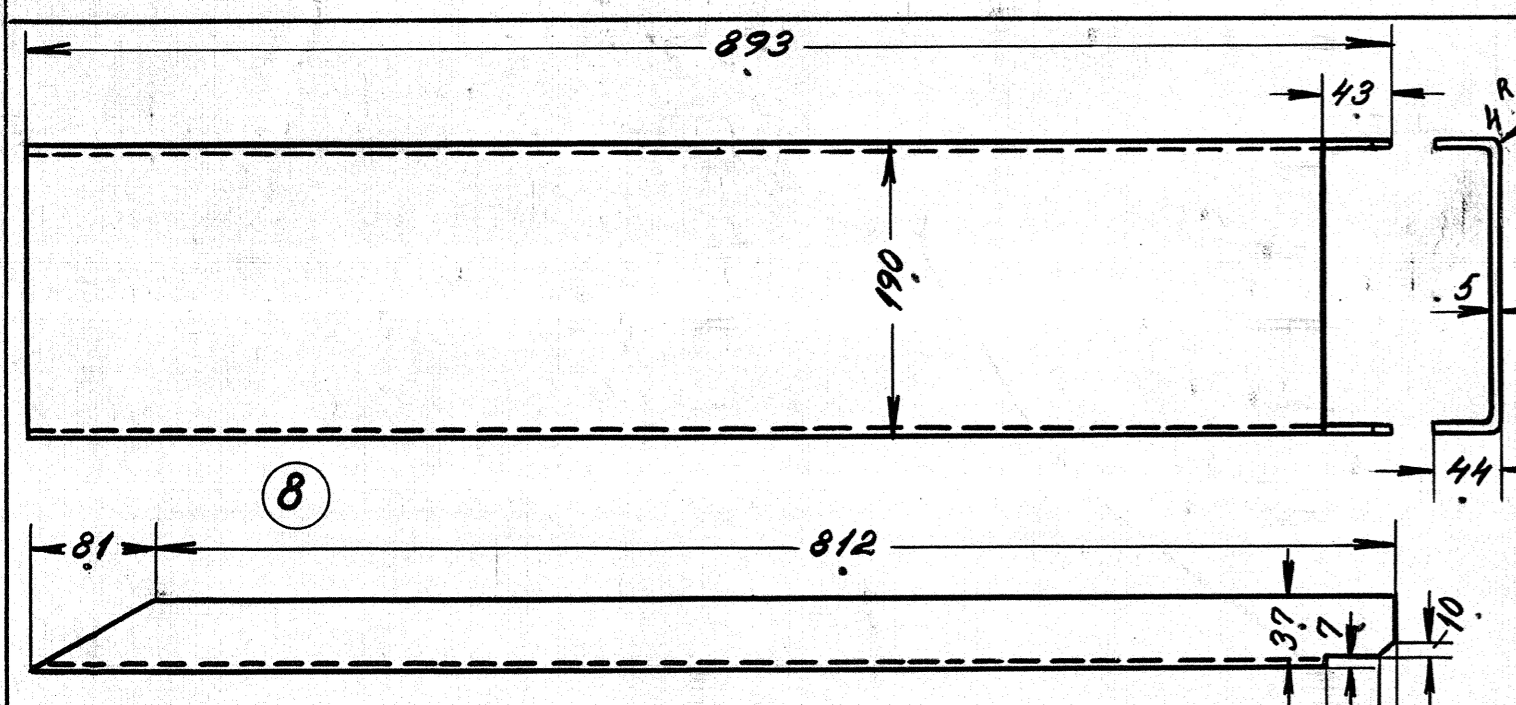

Ang. plac. se tegn. 18W-15.210

Betegnelse				afdækning	
Ant. i alt.	Pos.	Mat.	st.		
Ordr.	SML	6898	Tegn. 18W-15.220		

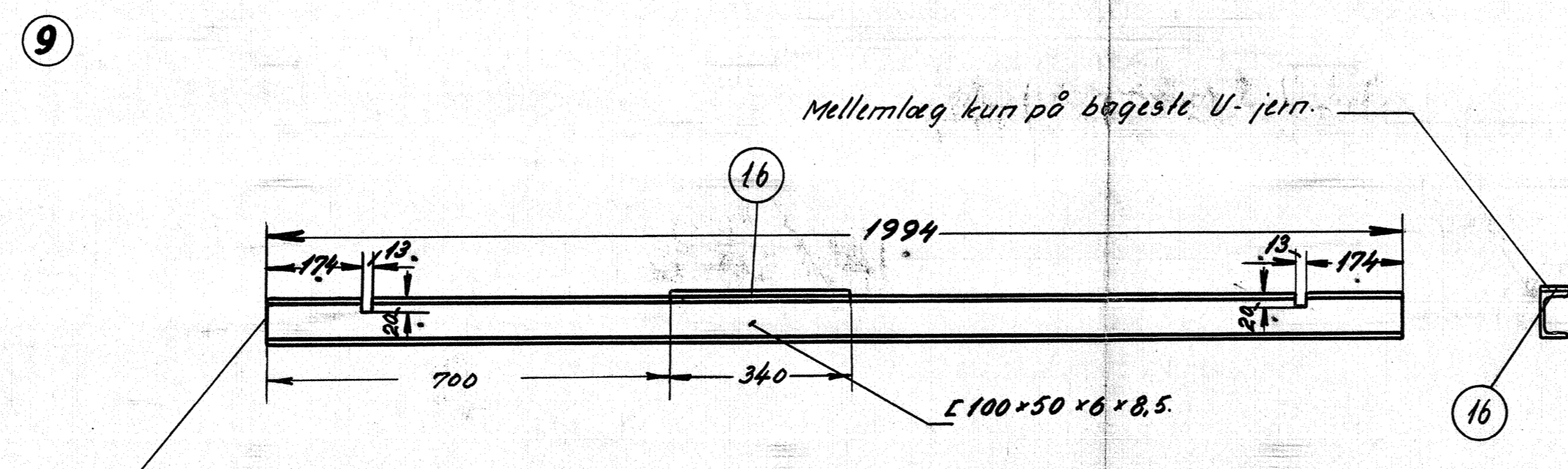

højre vognside for u-jern med mellemlæg
venstre " " uden

Ang. plac. se tegn. 18W-15.210

Betegnelse				lige u-jern	
Ant. i alt.	Pos.	Mat.	flussj.		
Ordr.	SML	6898	Tegn. 18W-15.220		

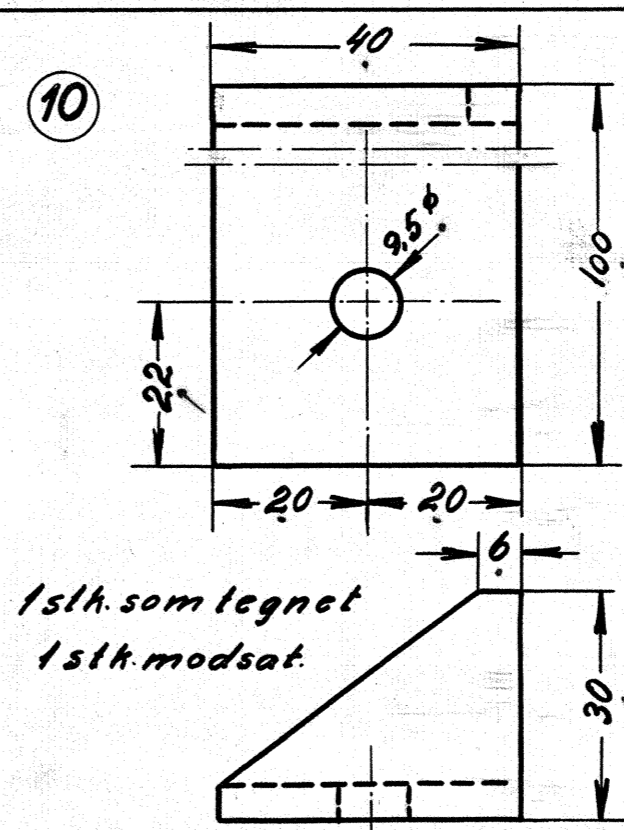

Istk. som tegnet
Istk. modsat.

Ang. plac. se tegn. 18W-15.210

Betegnelse				vinkelapp	
Ant. i alt.	Pos.	Mat.	flussj.		
Ordr.	SML	6898	Tegn. 18W-15.220		

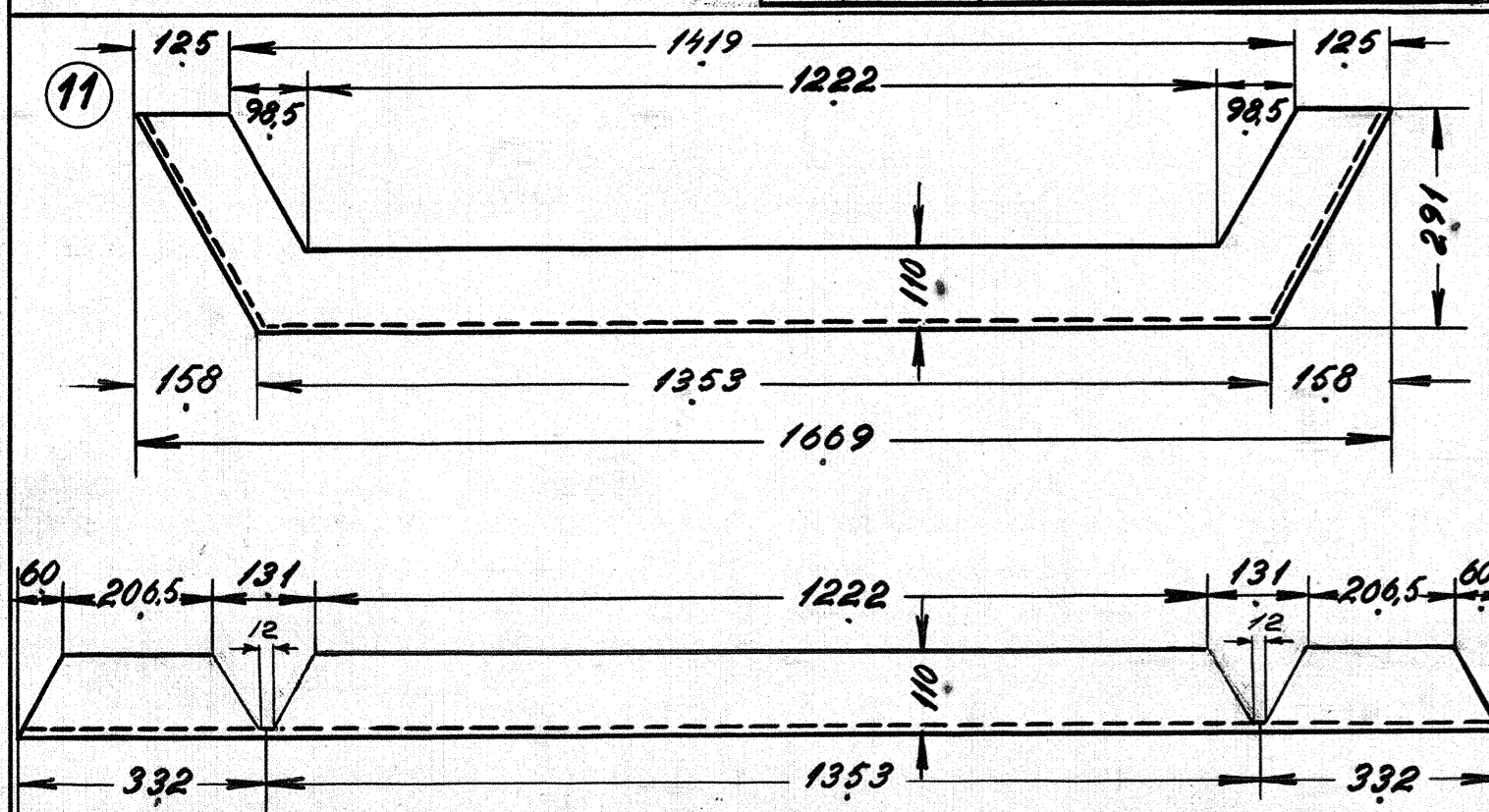

Ang. plac. se tegn. 18W-15.210

Betegnelse				vinkelafstivning	
Ant. i alt.	Pos.	Mat.	flussj.		
Ordr.	SML	6898	Tegn. 18W-15.220		

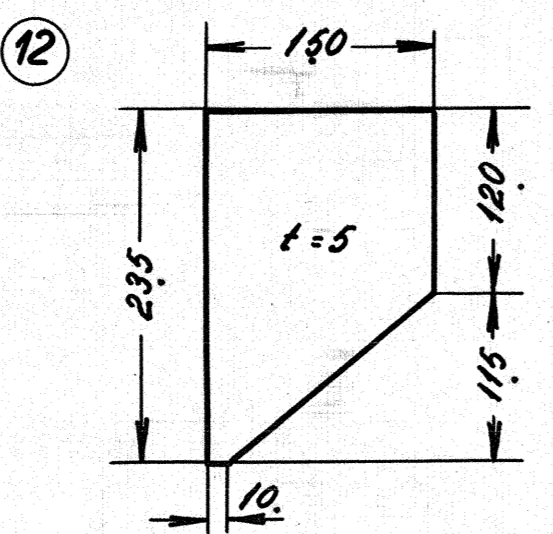

Ang. plac. se tegn. 18W-15.210

Betegnelse				afslivningsplade	
Ant. i alt.	Pos.	Mat.	flussj.		
Ordr.	SML	6898	Tegn. 18W-15.220		

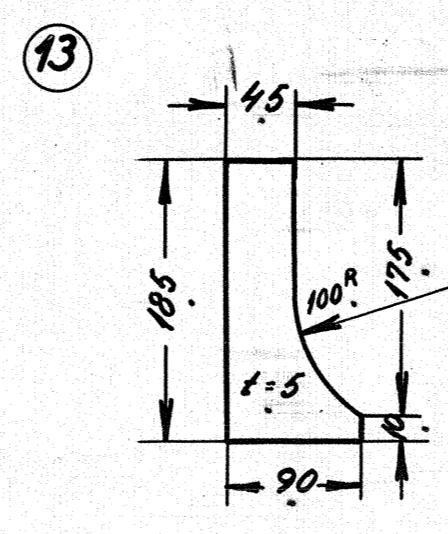

Ang. plac. se tegn. 18W-15.210

Betegnelse				afslivningsplade	
Ant. i alt.	Pos.	Mat.	flussj.		
Ordr.	SML	6898	Tegn. 18W-15.220		

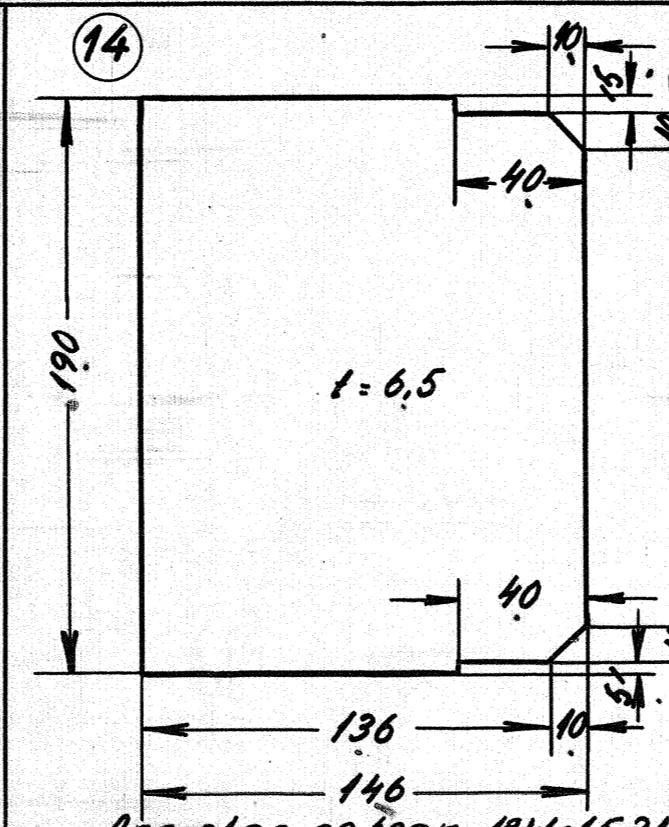

Ang. plac. se tegn. 18W-15.210

Betegnelse				afslivningsplade	
Ant. i alt.	Pos.	Mat.	flussj.		
Ordr.	SML	6898	Tegn. 18W-15.220		

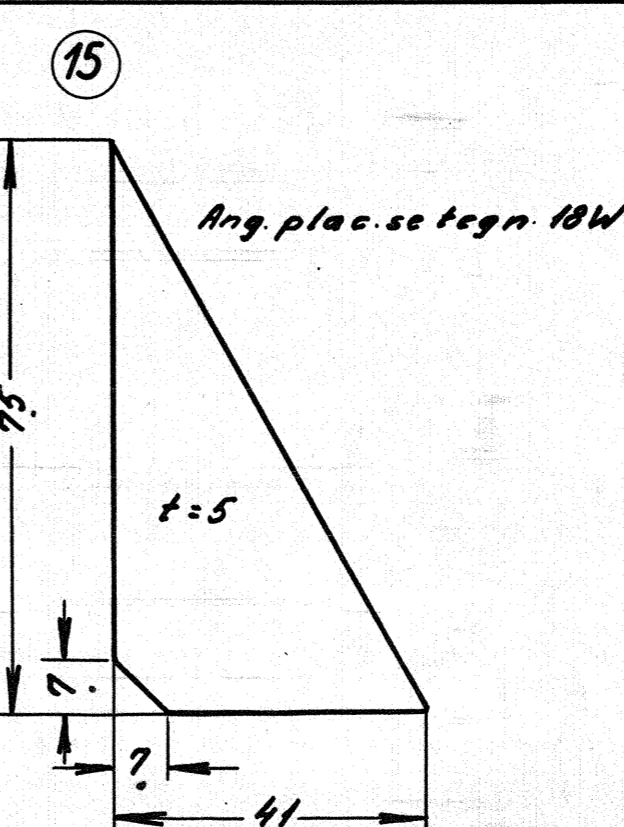

Ang. plac. se tegn. 18W-15.210

Betegnelse				hjørnestykke	
Ant. i alt.	Pos.	Mat.	flussj.		
Ordr.	SML	6898	Tegn. 18W-15.220		

Samlede vægt pr vogn 527,1 kg

1	mellemlæg	16	flussj.	50x6,5x350	0,89	0,87
4	hjørnestykke	15	flussj.	75x5x95	0,13	0,06
2	afslivningsplade	14	"	150x6,5x400	1,4	1,25
2	do.	13	"	200x5x150	0,63	0,35
4	afslivningsplade	12	"	150x6x700	1,41	1,04
2	vinkeljernsafdækning	11	"	110x110x10x400	33,7	32,0
2	vinkelapp	10	"	40x5x870	0,18	0,12
2	lige u-jern	9	flussj.	UNP 10x4000	42,1	42,3
2	afdækning	8	st. 42	190x90x5x900	9,54	9,0
4	vinkelapp	7	flussj.	50x50x6x320	0,3	0,2
2	afslivningsplade	6	"	500x200x6,5	2,4	1,7
2	plade	5	"	2400x1060x10	99,3	85,5
2	lapper	4	"	38x5x90	0,06	0,05
2	afslivningsplade	3	"	200x9x700	4,4	3,7
4	afslivningsplade	2	"	200x10x400	1,9	1,7
2	plade	1	flussj.	2400x940x13	114,5	103
SML	Betegnelse	Pos.	Materialer	Model nr eller materiale størrelse	rå vægt	terdelt vægt
Tegn. E.N.	Rev. E.P.	11/5 ST	Ard. II L			
Kalk. G.S. II-5-51	Norm.					
Målestok: 1:10, 1:5, 1:1, 1:2,5						
Data						
Vedh.						
Pos. 9 ændret H.M.P.						
Pos. 16 tilføjede H.M.P.						
2 stk. 28 huller i pos. 5 tilføjede H.M.P.						
Anvendelse						
Diesel-el. 500/550 hk. motorvogn.				Stylnr. 6898		
Tegnings benævnelse				Tegnings nummer		
Dele til parti ved indstigning.				18W-15.220		
Indeks: a b c d e						